



MITSUBISHI ELECTRIC AUTOMATION (THAILAND) CO., LTD.

Bang Chan Industrial Estate No. 111 Moo 4, Serithai Rd., T.Kannayao, A.Kannayao, BKK 10230 Thailand
 Tel: (66) 2517-1326, (66) 2919-9873 Fax: (66) 2517-1328 URL: www.meath-co.com E-mail: support@meath.co.th

บริษัท มิตซูบิชิ อิเล็กทริก ออโตเมชัน (ประเทศไทย) จำกัด

นิติบุคคลสาขารวมบางชิ้น เลขที่ 111 หมู่ 4 ถนนเสรีไทย แขวงคันนายาว เขตคันนายาว กทม. 10230

โทรศัพท์: (66) 2517-1326, (66) 2919-9873 โทรสาร: (66) 2517-1328 URL: www.meath-co.com E-mail: support@meath.co.th

MOTOR SPECIFICATION SHEET

MODEL : SF-PRV 0.75kW 4P

USED FOR : 400V CLASS

MANUFACTURER : MITSUBISHI ELECTRIC AUTOMATION (THAILAND) CO.,LTD.

DESCRIPTION	DETAIL				
PHASE	3				
MODEL NAME	SF-PRV				
RATED OUTPUT	0.75 kW				
POLE	4				
CODE	MEATH CODE : 1M002V-400075LING0				
OUTLINE DRAWING NO.	ONM84O260-*				
RATED VOLTAGE (V)	380	400	415	400	
RATED FREQUENCY (Hz)	50	50	50	60	
RATED CURRENT (A)	1.8	1.8	1.9	1.65	
RATED SPEED (min ⁻¹)	1410	1420	1430	1710	
RATED EFFICIENCY	83.5%	83.8%	83.5%	86.0%	
EFFICIENCY CLASS	IE3				
THERMAL CLASS	120 (E)				
RATING	S1 (CONTINUOUS)				
ENCLOSURE CONSTRUCTION	TOTALLY ENCLOSED FAN COOLED				
DEGREES OF PROTECTION	IP44				
METHOD OF COOLING	IC411				
FRAME NO.	80M				
WEIGHT (kg)	16				
STANDARD	IEC 60034-1, IEC 60034-30-1				
INSTALLATION	FLANGE MOUNTED (VERTICAL)				
ROTATION	CCW (VIEWED FROM SHAFT END)				
BEARING	LOAD SIDE : 6204ZZ				
	OPPOSITE SIDE : 6204ZZ				
BEARING GREASE	UREA GREASE				
NOISE (dB.A)*	50Hz : 49 / 60Hz : 50				
VIBRATION	V15				
CIRCUMSTANCE CONDITION	AMBIENT TEMPERATURE : -30 ~ +40°C				
	AMBIENT HUMIDITY : 100% RH (NO CONDENSATION)				
	ABOVE SEA LEVEL : 1000m OR BELOW				
	ENVIRONMENT : NO CORROSIVE/EXPLOSIVE GAS, NO STEAM OR CONDENSATION, MINIMAL DUST.				
COLOR	MUNSELL N7 (GRAY)				
TERMINAL BOX	NO. OF LEAD WIRES : 3				
	SOURCE CONNECTION : TERMINAL BLOCK				
SHAFT SWING	≤0.03mm				
MATERIAL	FRAME : STEEL PLATE				
	BRACKET LOAD SIDE : CAST IRON (FLANGE)				
	OPPOSITE SIDE : ALUMINIUM				
	SHAFT : CARBON STEEL				
	STATOR CORE : ELECTRICAL STEEL				
	WIRE : ENAMELLED COPPER MAGNET WIRE				
	ROTOR CORE : ELECTRICAL STEEL				
	CONDUCTOR : ALUMINIUM				
	TERMINAL BOX : STEEL PLATE				
	PAINTING : ALKYD-NITROCELLULOSE RESIN				
PRODUCTION COUNTRY	THAILAND				

*Value indicates representative value, not guaranteed value.

Specifications subject to change without notice.

SPECIFICATION SHEET NO.				
SS-M-8734-A				

MODEL SF-PRV THREE PHASE INDUCTION MOTOR OUTLINE DRAWING

INDOOR MOTOR

TOTALLY ENCLOSED FAN COOLED TYPE
 DEGREES OF PROTECTION IP44
 FLANGE NO. FF165

CUSTOMER _____
 USER _____
 FOR _____
 CUSTOMER'S ORDER NO. _____
 QUANTITY _____
 MFG. ORDER NO. _____

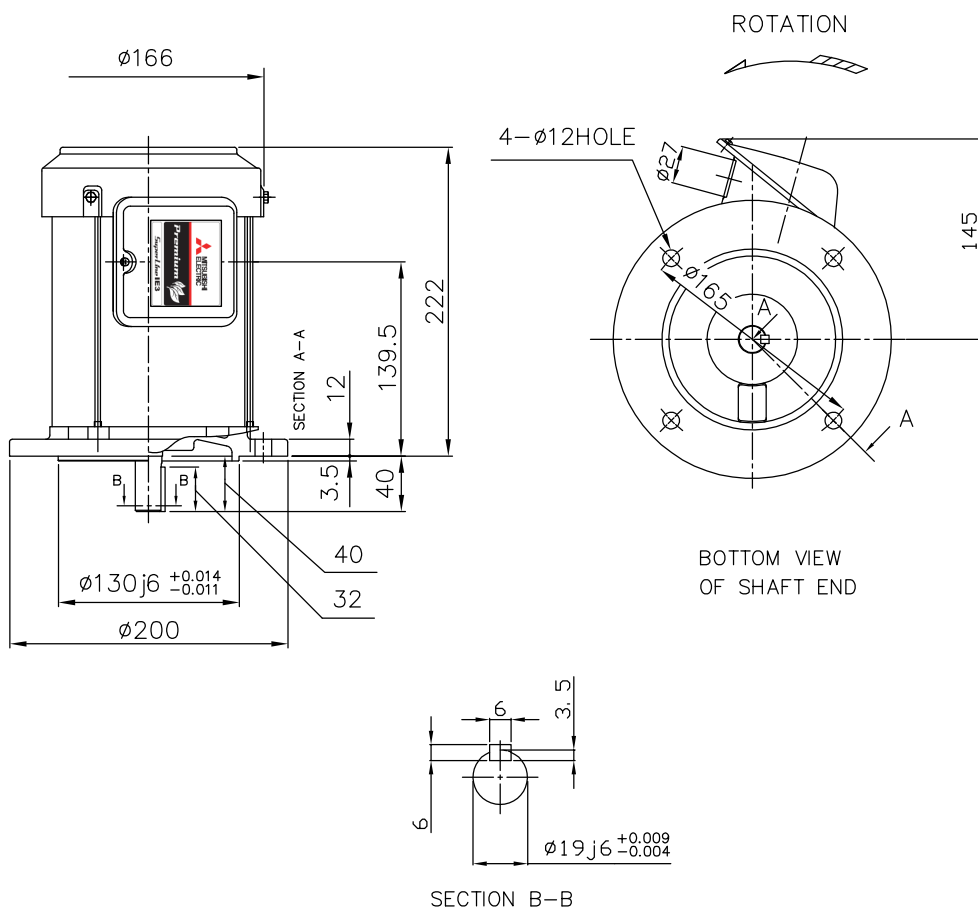

YOUR ORDER	FRAME SIZE	RATING	TH. CLASS	AMB. TEMP.	BEARINGS		COLOR	DIRECTION OF ROTATION (VIEWED FROM SHAFT END)	NO. OF TERMINALS	REMARKS
					LOAD SIDE	OPP. SIDE				
	80M	S1 (CONT.)	120(E)	40°C	6204ZZ	6204ZZ	GRAY (MUNSELL N7)	CCW	3	

YOUR ORDER	OUTPUT		RATE VOLTAGE	IE CODE-RATED EFF.						MASS(Kg)
	kW	POLE		50Hz				60Hz		
				200V	380V	400V	415V	200V	400V	
0.75	2	200V 50Hz 200V 60Hz	IE3-82.8%	-	-	-	IE3-82.9%	-	15	
0.75	2	380/400/415V 50Hz 400V 60Hz	-	IE3-82.0%	IE3-82.8%	IE3-83.0%	-	IE3-82.9%	15	
0.75	4	200V 50Hz 200V 60Hz	IE3-83.8%	-	-	-	IE3-86.0%	-	16	
0.75	4	380/400/415V 50Hz 400V 60Hz	-	IE3-83.5%	IE3-83.8%	IE3-83.5%	-	IE3-86.0%	16	

MITSUBISHI ELECTRIC AUTOMATION(THAILAND)CO.,LTD

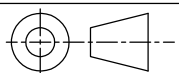

DIMENSION IN mm.
 SCALE : NTS

OUTLINE DRAWING NO.

0 N M 8 4 0 2 6 0

REV.

*