



MITSUBISHI ELECTRIC AUTOMATION (THAILAND) CO., LTD.
 Bang-Chan Industrial Estate No. 111 Moo 4, Serithai Rd., T.Kannayao, A.Kannayao, BKK 10230 Thailand
 Tel: (66) 2517-1326, (66) 2919-9873 Fax: (66) 2517-1328 URL: www.meath-co.com E-mail: support@meath.co.th
บริษัท มิทซูบิชิ อิเล็กทริก ออโตเมชั่น (ประเทศไทย) จำกัด
 นิคมอุตสาหกรรมบางชัน เลขที่ 111 หมู่ 4 ถนนเสรีไทย แขวงคันนายาว เขตคันนายาว กทม. 10230
 โทรศัพท์: (66) 2517-1326, (66) 2919-9873 โทรสาร: (66) 2517-1328 URL: www.meath-co.com E-mail: support@meath.co.th

MOTOR SPECIFICATION SHEET

MODEL : SF-QRGH 3HP 4P RATIO 1:25 (LT)
 USED FOR : GEAR MOTOR

DESCRIPTION	DETAIL			
PHASE	3			
MODEL NAME	SF-QRGH			
RATED OUTPUT, HP (kW)	3 (2.2)			
POLE	4			
CODE	MEATH CODE : 1G7025-0220N-LTQR0			
OUTLINE DRAWING NO.	ONM040343-B			
RATED VOLTAGE (V)	220	380	415	
RATED FREQUENCY (Hz)	50	50	50	
RATED CURRENT (A)	8.7	5.0	4.9	
RATED SPEED (min ⁻¹)	61	61	61.5	
RATED EFFICIENCY (%)	79.7	79.7	79.7	
EFFICIENCY CLASS	IE1			
THERMAL CLASS	155(F)			
RATING	S1 (CONTINUOUS)			
ENCLOSURE CONSTRUCTION	TOTALLY ENCLOSED FAN COOLED			
DEGREES OF PROTECTION	IP55			
METHOD OF COOLING	IC411			
FRAME NO.	100L			
WEIGHT (kg)	55			
STANDARD	IEC 60034-1, IEC 60034-30-1			
INSTALLATION	FOOT MOUNTED			
ROTATION	CCW (VIEWED FROM SHAFT END)			
BEARING	LOAD SIDE : 6306ZZ			
	OPPOSITE SIDE : 6205ZZ			
BEARING GREASE	UREA GREASE			
CIRCUMSTANCE CONDITION	AMBIENT TEMPERATURE : -20 ~ +40°C			
	AMBIENT HUMIDITY : 95%RH OR LESS			
	ABOVE SEA LEVEL : 1000m OR LESS			
	ENVIRONMENT : NO BURSTING/EROSIVE GAS OR VAPOR			
COLOR	MUNSELL N1.5 (BLACK)			
TERMINAL BOX	NO. OF LEAD WIRES : 6			
	SOURCE CONNECTION : TERMINAL BLOCK			
GEAR RATIO	1:25			
GEAR LUBRICANT	GREASE (Filled from factory.)			
SERVICE FACTOR	1.4			
MATERIAL	FRAME : STEEL PLATE			
	BRACKET (GEAR SIDE) : CAST IRON			
	BRACKET (OPP SIDE) : ALUMINIUM			
	GEAR CASE : CAST IRON			
	SHAFT (MOTOR) : STEEL			
	SHAFT (GEAR OUTPUT) : STEEL			
	STATOR CORE : ELECTRICAL STEEL			
	WIRE : ENAMELLED COPPER MAGNET WIRE			
	ROTOR CORE : ELECTRICAL STEEL			
	CONDUCTOR : ALUMINIUM			
	TERMINAL BOX : STEEL PLATE			
	PAINTING : POLYURETHANE RESIN			
PRODUCTION COUNTRY	THAILAND			

Specifications subject to change without notice.

SPECIFICATION SHEET NO.				
SS-M-0897-C				

MODEL SF-QRGH THREE PHASE INDUCTION MOTOR OUTLINE DRAWING

GEAR MOTOR
 TOTALLY ENCLOSED FAN COOLED
 DEGREES OF PROTECTION IP55
 DUST & WATER JET PROOF

CUSTOMER _____
 USER _____
 FOR _____
 CUSTOMER'S ORDER NO. _____
 QUANTITY _____
 MFG. ORDER NO. _____

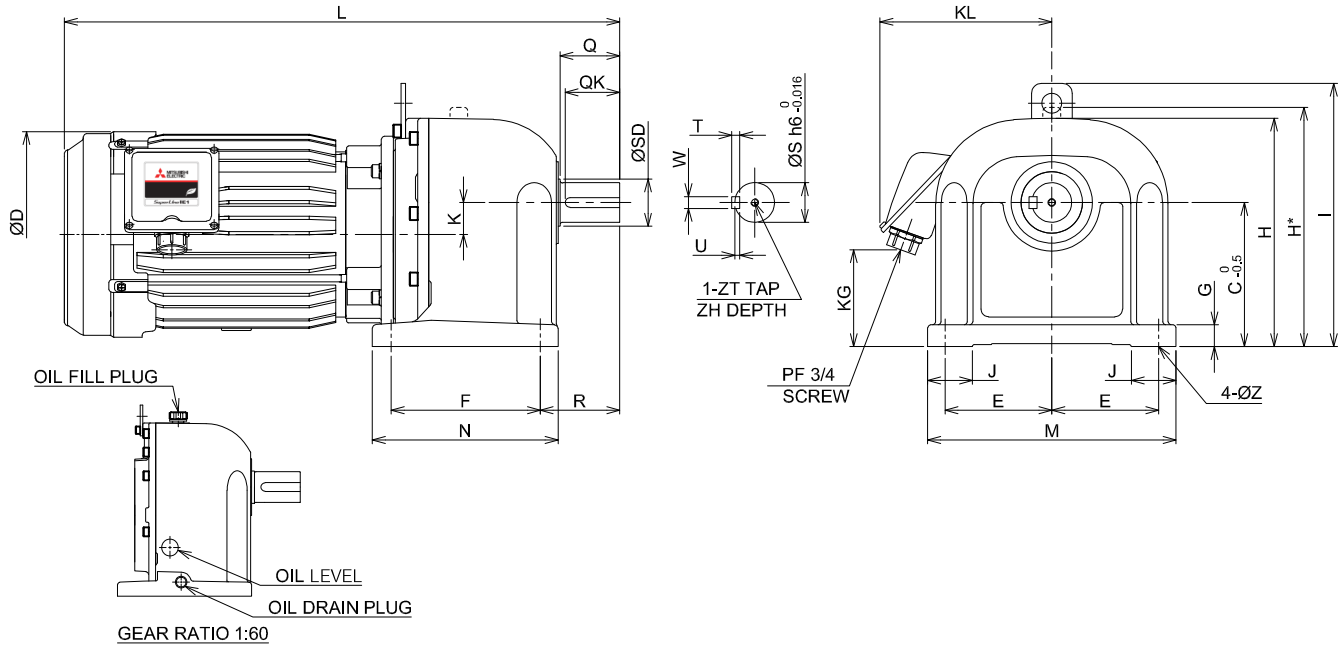

YOUR ORDER	GEAR RATIO	DIMENSION(mm.)																				WEIGHT (kg.)					
		L	Q	QK	ØD	K	F	R	N	T	W	U	ZT	ZH	ØS	ØSD	KL	KG	J	E	M		G	C	H	I	ØZ
	1:3~1:30	559	60	55	207	32	150	80	187	8	12	5	M8	12	40	45	170	90	45	107.5	250	22	145	230	265	15	55
	1:40,1:50	585	75	70	207	40	170	95	206	9	14	5.5	M8	12	48	50	170	107	50	125	285	22	170	275	310	15	73
	1:60	627.5	82	71	207	50	200	107	240	10	16	6	M10	18	55	58	170	122	60	130	300	25	195	330	345	19	90

YOUR ORDER	MOTOR FRAME SIZE	RATING	TH. CLASS	AMB. TEMP	BEARINGS		COLOR	GEAR RATIO	DIRECTION OF ROTATION (VIEWED FROM SHAFT END)	NO. OF LEAD WIRES	REMARKS
					LOAD SIDE	OPP. SIDE					
	100L	S1 (CONT.)	155(F)	40°C	6306ZZ	6205ZZ	BLACK (MUNSELL N1.5)	1:3~1:30 1:40~1:60	CCW CW	6	

YOUR ORDER	RATIO	SERVICE FACTOR	MOTOR HP	OUTPUT kW	POLE	VOLT	HERTZ	OUTPUT SPEED (min ⁻¹)	AMP.	IE CODE-RATED EFF.	TYPE	LUBRICATION TYPE
	1:3	1.4	3	2.2	4	220/380/415	50	465/465/470	8.7/5.0/4.9	IE1-79.7%/79.7%/79.7%	LT	GREASE ⁽¹⁾
	1:5	1.4	3	2.2	4	220/380/415	50	285/285/290				
	1:10	1.4	3	2.2	4	220/380/415	50	142/142/143				
	1:15	1.4	3	2.2	4	220/380/415	50	97/97/98				
	1:20	1.4	3	2.2	4	220/380/415	50	75/75/75.5				
	1:25	1.4	3	2.2	4	220/380/415	50	61/61/61.5				
	1:30	1.4	3	2.2	4	220/380/415	50	48/48/48.5				
	1:40	1.4	3	2.2	4	220/380/415	50	36/36/36.5				
	1:50	1.4	3	2.2	4	220/380/415	50	31.5/31.5/31.5				
	1:60	1.4	3	2.2	4	220/380/415	50	24/24/24				OIL ⁽²⁾

NOTE : (1) GREASE HAD BEEN FILLED FROM MANUFACTURER ALREADY.
 (2) PLEASE FILL IN OIL BEFORE FIRST TIME USAGE. (SEE DETAIL IN THE INSTRUCTION MANUAL)

MITSUBISHI ELECTRIC AUTOMATION (THAILAND) CO.,LTD.

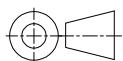

DIMENSION IN mm.
 SCALE : NTS

OUTLINE DRAWING NO.

ONM040343

REV. B