



MITSUBISHI ELECTRIC AUTOMATION (THAILAND) CO., LTD.

Bang-Chan Industrial Estate No. 111 Moo 4, Serithai Rd., T.Kannayao, A.Kannayao, BKK 10230 Thailand
 Tel: (66) 2517-1326, (66) 2919-9873 Fax: (66) 2517-1328 URL: www.meath-co.com E-mail: support@meath.co.th

บริษัท มิตซูบิชิ อิเล็กทริก ออโตเมชัน (ประเทศไทย) จำกัด

นิติบุคคลสาขารวมบางชิ้น เลขที่ 111 หมู่ 4 ถนนเสรีไทย แขวงคันนายาว เขตคันนายาว กทม. 10230
 โทรศัพท์: (66) 2517-1326, (66) 2919-9873 โทรสาร: (66) 2517-1328 URL: www.meath-co.com E-mail: support@meath.co.th

MOTOR SPECIFICATION SHEET

MODEL : SF-Q 60HP 2P (LT)

USED FOR : STANDARD

DESCRIPTION	DETAIL			
PHASE	3			
MODEL NAME	SF-Q			
RATED OUTPUT, HP (kW)	60 (45)			
POLE	2			
CODE	MEATH CODE : 1M002F-204500Q-GD0			
OUTLINE DRAWING NO.	ONM44O306-D			
RATED VOLTAGE (V)	220	380	415	
RATED FREQUENCY (Hz)	50	50	50	
RATED CURRENT (A)	147	85.0	80.3	
RATED SPEED (min ⁻¹)	2960	2960	2970	
RATED EFFICIENCY (%)	91.7	91.7	92.3	
EFFICIENCY CLASS	IE1			
THERMAL CLASS	155(F)			
RATING	S1 (CONTINUOUS)			
ENCLOSURE CONSTRUCTION	TOTALLY ENCLOSED FAN COOLED			
DEGREES OF PROTECTION	IP55			
METHOD OF COOLING	IC411			
FRAME NO.	200L			
WEIGHT (kg)	326			
STANDARD	IEC 60034-1, IEC 60034-30-1			
INSTALLATION	FOOT MOUNTED			
ROTATION	CCW (VIEWED FROM SHAFT END)			
BEARING	LOAD SIDE : 6312ZC3			
	OPPOSITE SIDE : 6311ZC3			
BEARING GREASE	UREA GREASE			
NOISE (dB.A)	93			
VIBRATION	V15			
CIRCUMSTANCE CONDITION	AMBIENT TEMPERATURE : -20 ~ +40°C			
	AMBIENT HUMIDITY : 95%RH OR LESS			
	ABOVE SEA LEVEL : 1000m OR LESS			
	ENVIRONMENT : NO BURSTING/EROSIVE GAS OR VAPOR			
COLOR	MUNSELL N1.5 (BLACK)			
TERMINAL BOX	NO. OF LEAD WIRES : 6			
	SOURCE CONNECTION : LEAD WIRES			
SHAFT SWING	≤0.05mm			
MATERIAL	FRAME : CAST IRON			
	BRACKET : CAST IRON			
	SHAFT : CARBON STEEL			
	STATOR CORE : ELECTRICAL STEEL			
	WIRE : ENAMELLED COPPER MAGNET WIRE			
	ROTOR CORE : ELECTRICAL STEEL			
	CONDUCTOR : ALUMINIUM			
	TERMINAL BOX : CAST IRON			
	PAINTING : POLYURETHANE RESIN			
PRODUCTION COUNTRY	THAILAND			

Specifications subject to change without notice.

SPECIFICATION SHEET NO.				
SS-N-4222-A				

MODEL SF-Q THREE PHASE INDUCTION MOTOR OUTLINE DRAWING

TOTALLY ENCLOSED FAN COOLED
 DEGREES OF PROTECTION IP55
 DUST & WATER JET PROOF

CUSTOMER _____
 USER _____
 FOR _____
 CUSTOMER'S ORDER NO. _____
 QUANTITY _____
 MFG. ORDER NO. _____

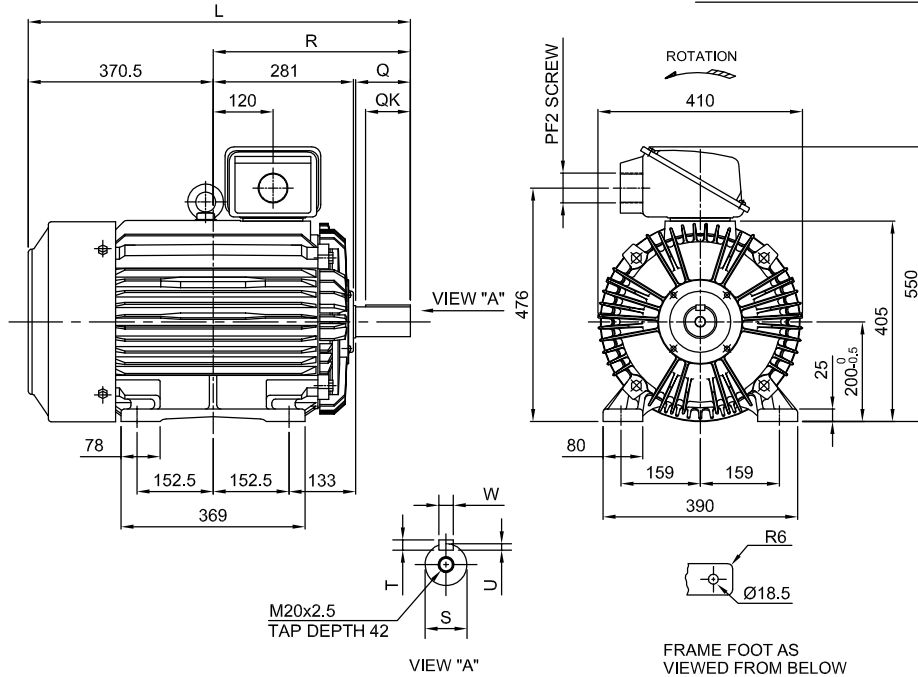

POLES	DIMENSION							
	L	Q	QK	R	S	T	U	W
2P	766	110	90	395.5	Ø55m6 ^{+0.030} / _{+0.011}	10	6	16
4P,6P	796	140	110	425.5	Ø60m6 ^{+0.030} / _{+0.011}	11	7	18

YOUR ORDER	FRAME SIZE	RATING	TH. CLASS	AMB. TEMP.	BEARINGS				COLOR	DIRECTION OF ROTATION (VIEWED FROM SHAFT END)	NO. OF LEAD WIRES	REMARKS
					LOAD SIDE		OPP. SIDE					
	200L	S1 (CONT.)	155(F)	40°C	6312ZZC3 (2POLE)	6313ZZ (4,6POLE)	6311ZZC3 (2POLE)	6311ZZ (4,6POLE)	BLACK (MUNSELL N1.5)	CCW	6	

YOUR ORDER	OUTPUT		POLES	VOLTS	HERTZ	AMP.	RPM.	IE CODE-RATED EFF.	REMARKS
	HP	kW							
	50	37	2	380/415	50	69.9/66.3	2960/2970	IE1- 91.6%/91.8%	HT
	60	45	2	380/415	50	84.6/81.1	2960/2970	IE1- 91.9%/91.7%	HT
	50	37	4	380/415	50	73.6/72.0	1475/1480	IE1- 91.2%/91.2%	HT
	60	45	4	380/415	50	88.3/85.9	1470/1475	IE1- 91.7%/91.7%	HT
	40	30	6	380/415	50	61.1/59.0	975/980	IE1- 90.2%/90.2%	HT
	50	37	6	380/415	50	75.1/74.0	975/980	IE1- 90.8%/90.8%	HT
	50	37	2	220/380/415	50	122/70.3/66.7	2965/2965/2970	IE1- 91.6%/91.6%/91.8%	LT
	60	45	2	220/380/415	50	147/85.0/80.3	2960/2960/2970	IE1- 91.7%/91.7%/92.3%	LT
	50	37	4	220/380/415	50	126.4/73.0/70.0	1470/1470/1475	IE1- 91.2%/91.2%/91.2%	LT
	60	45	4	220/380/415	50	152.9/88.3/85.5	1470/1470/1475	IE1- 91.7%/91.7%/91.7%	LT
	40	30	6	220/380/415	50	106/61.1/59.5	975/975/980	IE1- 90.2%/90.2%/90.2%	LT
	50	37	6	220/380/415	50	129/74.3/71.7	975/975/980	IE1- 90.8%/90.8%/90.8%	LT

MITSUBISHI ELECTRIC AUTOMATION (THAILAND) CO., LTD.

	OUTLINE DRAWING NO.	REV.
	DIMENSION IN mm.	ONM440306
SCALE : NTS		