

MOTOR SPECIFICATION SHEET

MODEL : SF-QRGC 10HP 4P RATIO 1:25 (LT)

USED FOR : GEAR MOTOR

DESCRIPTION	DETAIL			
PHASE	3			
MODEL NAME	SF-QRGC			
RATED OUTPUT, HP (kW)	10 (7.5)			
POLE	4			
CODE	MEATH CODE : 1G1025-100H6165QR0			
OUTLINE DRAWING NO.	ONM24O328-A			
RATED VOLTAGE (V)	220	380	415	
RATED FREQUENCY (Hz)	50	50	50	
RATED CURRENT (A)	26.8	15.5	15.0	
RATED SPEED (min ⁻¹) *	58	58	58	
RATED EFFICIENCY (%)	86.0	86.0	86.2	
EFFICIENCY CLASS	IE1			
THERMAL CLASS	155(F)			
RATING	S1 (CONTINUOUS)			
ENCLOSURE CONSTRUCTION	TOTALLY ENCLOSED FAN COOLED			
DEGREES OF PROTECTION	IP55			
METHOD OF COOLING	IC411			
FRAME NO.	132M			
WEIGHT (kg)	136			
STANDARD	IEC 60034-1, IEC 60034-30-1			
INSTALLATION	FOOT MOUNTED			
ROTATION	CW (VIEWED FROM SHAFT END)			
BEARING	LOAD SIDE : 6308ZZ			
	OPPOSITE SIDE : 6207ZZ			
BEARING GREASE	UREA GREASE			
CIRCUMSTANCE CONDITION	AMBIENT TEMPERATURE : -20 ~ +40°C			
	AMBIENT HUMIDITY : 95%RH OR LESS			
	ABOVE SEA LEVEL : 1000m OR LESS			
	ENVIRONMENT : NO BURSTING/EROSIVE GAS OR VAPOR			
COLOR	MUNSELL N1.5 (BLACK)			
TERMINAL BOX	NO. OF LEAD WIRES : 6			
	SOURCE CONNECTION : TERMINAL BLOCK			
GEAR RATIO	1:25			
GEAR LUBRICANT	OIL (Must be filled by user.)			
SERVICE FACTOR	1.79			
MATERIAL	FRAME : STEEL PLATE			
	BRACKET (GEAR SIDE) : CAST IRON			
	BRACKET (OPP SIDE) : ALUMINIUM			
	GEAR CASE : CAST IRON			
	SHAFT (MOTOR) : STEEL			
	SHAFT (GEAR OUTPUT) : STEEL			
	STATOR CORE : ELECTRICAL STEEL			
	WIRE : ENAMELLED COPPER MAGNET WIRE			
	ROTOR CORE : ELECTRICAL STEEL			
	CONDUCTOR : ALUMINIUM			
	TERMINAL BOX : STEEL PLATE			
	PAINTING : POLYURETHANE RESIN			
	PRODUCTION COUNTRY	THAILAND		

* THIS VALUE IS CALCULATED BY " MOTOR RATED SPEED / GEAR RATIO ".

(SPECIFICATION VALUE IS 58 min⁻¹ .)

Specifications subject to change without notice.

SPECIFICATION SHEET NO.				
SS-M-2854-B				

MODEL SF-QRGC THREE PHASE INDUCTION MOTOR OUTLINE DRAWING

GEAR MOTOR
 TOTALLY ENCLOSED FAN COOLED
 DEGREES OF PROTECTION IP55
 DUST & WATER JET PROOF

CUSTOMER _____
 USER _____
 FOR _____
 CUSTOMER'S ORDER NO. _____
 QUANTITY _____
 MFG. ORDER NO. _____

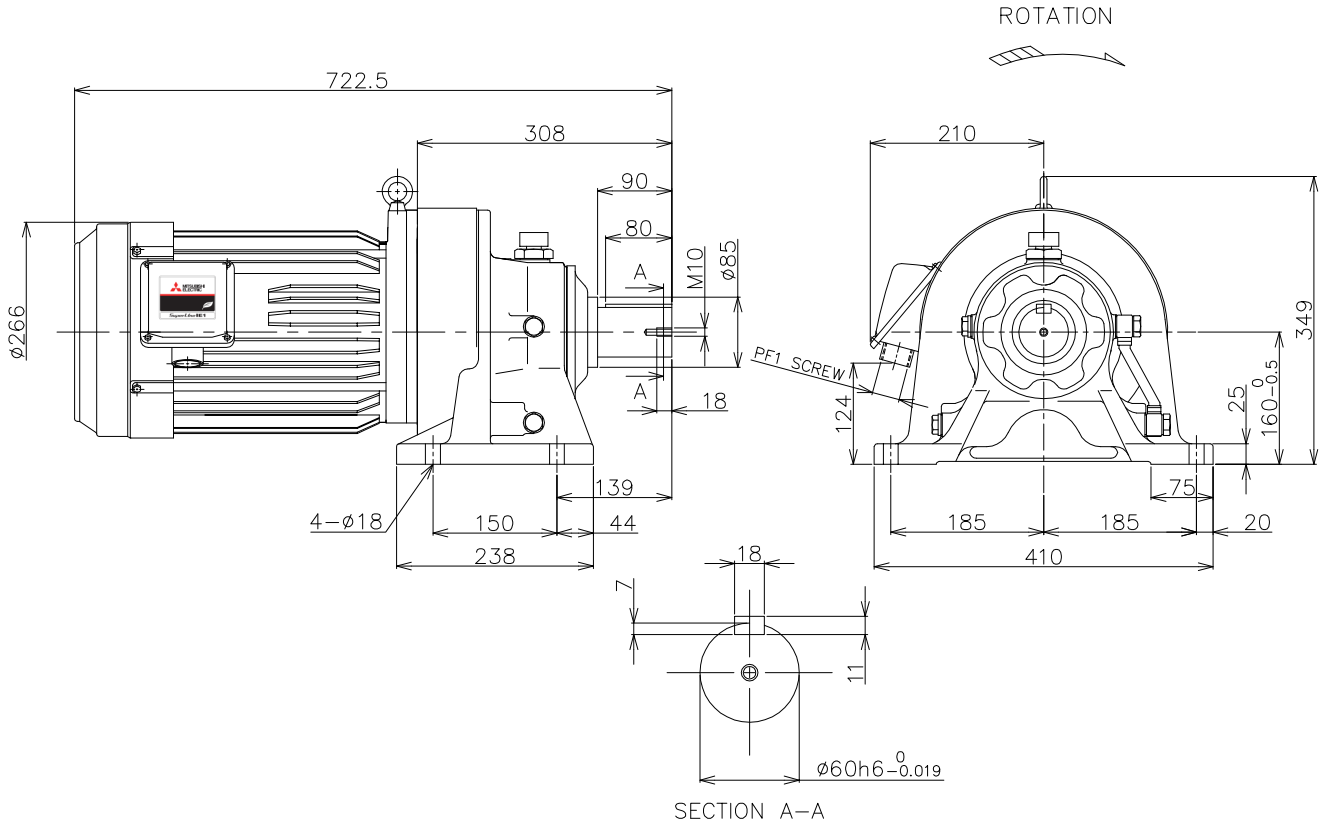

YOUR ORDER	MOTOR FRAME SIZE	RATING	TH. CLASS	AMB. TEMP	BEARINGS		COLOR	DIRECTION OF ROTATION (VIEWED FROM SHAFT END)	NO. OF LEAD WIRES	REMARKS
					LOAD SIDE	OPP. SIDE				
	132M	S1 (CONT.)	155(F)	40°C	6308ZZ	6207ZZ	BLACK (MUNSELL N1.5)	CW	6	

YOUR ORDER	GEAR MODEL	RATIO	SERVICE FACTOR	MOTOR OUTPUT		POLE	VOLT	HERTZ	OUTPUT SPEED (min ⁻¹)	AMP.	IE CODE-RATED EFF.	TYPE	LUBRICATION TYPE	WEIGHT (kg)
				HP	KW									
	CHHM10-6165-25	1:25	1.79	10	7.5	4	220/380/415	50	58	26.8/15.5/15.0	IE1-86.0%/86.0%/86.2%	LT	OIL ⁽¹⁾	136
	CHHM10-6165-29	1:29	1.52	10	7.5	4	220/380/415	50	50					
	CHHM10-6165-35	1:35	1.28	10	7.5	4	220/380/415	50	41					
	CHHM10-6165-25	1:25	1.79	10	7.5	4	380/415	50	58	15.4/14.7	IE1-86.0%/86.7%	HT		
	CHHM10-6165-29	1:29	1.52	10	7.5	4	380/415	50	50					
	CHHM10-6165-35	1:35	1.28	10	7.5	4	380/415	50	41					

NOTE : (1) PLEASE FILL IN OIL BEFORE FIRST TIME USAGE.(SEE DETAIL IN THE INSTRUCTION MANUAL)

MITSUBISHI ELECTRIC AUTOMATION (THAILAND) CO., LTD.

		OUTLINE DRAWING NO.	REV.
DIMENSION IN mm.		0 N M 2 4 0 3 2 8	A
SCALE : NTS			