

MOTOR SPECIFICATION SHEET

MODEL : SF-QRVB 1/2HP 4P (LT)

USED FOR : BRAKE MOTOR

DESCRIPTION	DETAIL			
PHASE	3			
MODEL NAME	SF-QRVB			
RATED OUTPUT, HP (kW)	1/2 (0.4)			
POLE	4			
CODE	MEATH CODE : 1M002X-400040QGGD0			
OUTLINE DRAWING NO.	ONM74O382-B			
RATED VOLTAGE (V)	220	380	415	
RATED FREQUENCY (Hz)	50	50	50	
RATED CURRENT (A)	2.00	1.14	1.18	
RATED SPEED (min ⁻¹)	1400	1400	1420	
RATED EFFICIENCY (%)	73.3	73.3	72.0	
EFFICIENCY CLASS	IE1			
THERMAL CLASS	155(F)			
RATING	S1 (CONTINUOUS)			
ENCLOSURE CONSTRUCTION	TOTALLY ENCLOSED FAN COOLED			
DEGREES OF PROTECTION	IP55			
METHOD OF COOLING	IC411			
FRAME NO.	71M			
WEIGHT (kg)	12			
STANDARD	IEC 60034-1, IEC 60034-30-1			
INSTALLATION	FLANGE MOUNTED (VERTICAL)			
ROTATION	CCW (VIEWED FROM SHAFT END)			
BEARING	LOAD SIDE : 6202ZZ			
	OPPOSITE SIDE : 6202ZZ			
BEARING GREASE	UREA GREASE			
CIRCUMSTANCE CONDITION	AMBIENT TEMPERATURE : -20 ~ +40°C			
	AMBIENT HUMIDITY : 95%RH OR LESS			
	ABOVE SEA LEVEL : 1000m OR LESS			
	ENVIRONMENT : NO BURSTING/EROSIVE GAS OR VAPOR			
COLOR	MUNSELL N1.5 (BLACK)			
TERMINAL BOX	NO. OF LEAD WIRES : 6			
	SOURCE CONNECTION : TERMINAL BLOCK			
MATERIAL	FRAME : STEEL PLATE			
	BRACKET LOAD SIDE : CAST IRON			
	OPPOSITE SIDE : CAST IRON			
	SHAFT : CARBON STEEL			
	STATOR CORE : ELECTRICAL STEEL			
	WIRE : ENAMELLED COPPER MAGNET WIRE			
	ROTOR CORE : ELECTRICAL STEEL			
	CONDUCTOR : ALUMINIUM			
	TERMINAL BOX : STEEL PLATE			
	PAINTING : POLYURETHANE RESIN			
BRAKE	TYPE : TB-A0.4 (DC)			
	RATED BRAKING TORQUE : 4 N.m			
	ELECTROMAGNETIC STROKE : INITIAL = 0.15 mm., ADJUSTABLE LIMIT = 0.4 mm.			
PRODUCTION COUNTRY	THAILAND			

Specifications subject to change without notice.

SPECIFICATION SHEET NO.				
SS-N-7052-A				

MODEL SF-QRVB THREE PHASE INDUCTION MOTOR OUTLINE DRAWING

TOTALLY ENCLOSED FAN COOLED
 DEGREES OF PROTECTION IP55
 DUST & WATER JET PROOF
 VERTICAL TYPE BRAKE MOTOR
 BRAKE TYPE TB-A

CUSTOMER _____
 USER _____
 FOR _____
 CUSTOMER'S ORDER NO. _____
 QUANTITY _____
 MFG. ORDER NO. _____

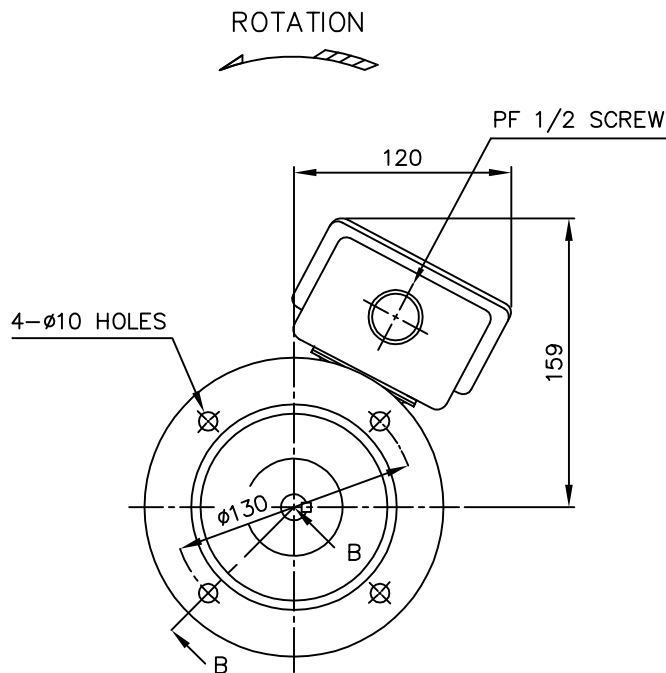
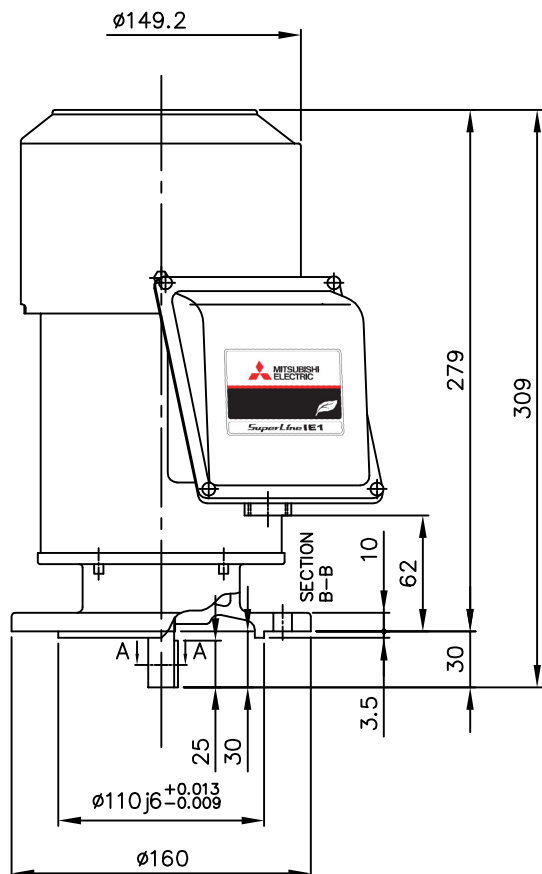

BOTTOM VIEW OF SHAFT END

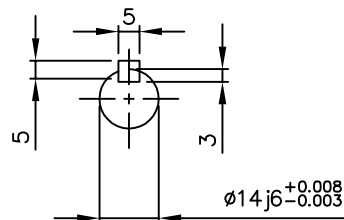

SECTION A-A

BRAKE TYPE	RATED DAMPING TORQUE(N.m)	ELECTROMAGNETIC STROKE(mm.)	
		INITIAL	ADJUSTABLE LIMIT
TB-A0.4	4	0.15	0.4

YOUR ORDER	FRAME SIZE	RATING	TH. CLASS	AMB. TEMP.	BEARINGS		COLOR	DIRECTION OF ROTATION (VIEWED FROM SHAFT END)	NO. OF LEAD WIRES
					LOAD SIDE	OPP. SIDE			
	71M	S1 (CONT.)	155(F)	40°C	6202ZZ	6202ZZ	BLACK (MUNSELL N1.5)	CCW	6

YOUR ORDER	OUTPUT		POLES	VOLTS	HERTZ	AMP.	RPM	IE CODE-RATED EFF.	REMARKS
	HP	kW							
	1/2	0.4	4	220/380/415	50	2.00/1.14/1.18	1400/1400/1420	IE1 73.3/73.3/72.0	LT
	1/4	0.2	6	220/380/415	50	1.23/0.71/0.74	920/920/930	IE1 64.5/64.5/63.5	LT

MITSUBISHI ELECTRIC AUTOMATION (THAILAND) CO., LTD.

	OUTLINE DRAWING NO.	REV.
	0 N M 7 4 0 3 8 2	B

DIMENSION IN mm.

SCALE : NTS